

PROJECT:	
SCHEDULE:	DATE:
PREPARE BY:	
NOTES:	

DESCRIPTION

CELS SPARKLE CFL-039 is a Bluetooth and DMX Control RGBW lighting for Facade and Architectural Decorative applications.

APPLICATIONS

Widely used for Facades appearance, Town square, Bridges, Trees, floodlights, wall washers etc.

FEATURES

- CREE brand RGB/RGBW LED chips with high brightness, good color effect, low heat and long lifespan.
- Using Mean Well LED driver which is one of the best driver brand in the world.
- Multiple optics from super spot to wide flood.
- Support very narrow beam angles from 3.8 to 8 degree. The longest illuminating distance is more than 200 meters.
- Support multiple color changing effects: Flashing, Strobing, Jumping, Fading, Smoothing etc.
- The luminaire is outdoor rated IP66 (waterproof).
- Support DMX function, Customizable wireless solution, RF remote control solution.

**Please consult us for details.*



Rated Life Hours upto 50,000hrs
Warranty 5 Years

NEW FEATURES

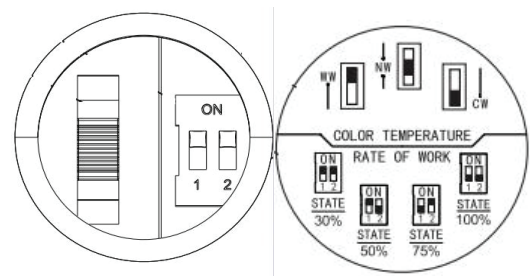

ELECTRICAL INFORMATION

MODEL NO	CFL-039-035	CFL-039-100	CFL-039-150
Power Consumption (±5%)	35W±5	100W±5	150W±8
Power Supply	SOSEN/MOSO/CZCL		
Input Voltage	AC 100-277VAC/50 / 60 Hz		
Power Factor	>0.92		
SurgeProtection	SOSEN: 10kV lline-earth, 6kV line-line / MOSO: 10kV lline-earth, 5kV line-line		
	CZCL: 6kV lline-earth, 4kV line-line		
Driver Type	Constant Current (CC)/Constant Voltage (CV)		
Certification	0-10V dim/DMX control		

OPTIC INFORMATION

LED type	CREE-XPG3		
Luminous Flux (±5%)	3500lm/2450lm (with honeycomb film)	10000lm/7000lm (with honeycomb film)	15000lm/10500lm (with honeycomb film)
Efficacy(4000K RA80)	100lm/W /70lm/W (with honeycomb film)		
Color Temperature	4000K (3000K, 5000K adjustable), RGB, RGBW		
Color Rendering Index	Ra 80 (Ra70, Ra90 optional)		
Beam Angle	F00111/F00113/F00114/F00115/F00116/F00117		
UGR level	NA		
	CREE-XPE2		
Luminous Flux (±5%)	2450lm	7000lm	10500lm
Efficacy(4000K RA80)	70lm/W		
Color Temperature	4000K (2200K,3000K, 5000K optional)/RGB/RGBW/CCT adjustable (2200-4000k)		
Color Rendering Index	Ra 80 (Ra70, Ra90 optional)		
Beam Angle	F00110/F00118		
UGR level	NA		

DIMENSIONS AND MOUNT

Product Dimension	219.5x330x100mm (8.64''x12.99''x3.94'')	450x452x160mm (17.72''x17.79''x6.30'')
Luminaire Net Weight	3.7±0.3kg (8.15±0.66Lbs)	10±0.3kg (22.04±0.66Lbs)
Export Carton Size mm(inch)	360x290x180mm (14.17''x11.41''x7.08'')	525x495x235mm (20.66''x19.48''x9.25'')
Gross Weight (±0.3kg/0.66Lbs)	4.5±0.3kg (9.92±0.66Lbs)	11.5±0.3kg (25.35±0.66Lbs)
Mounting Option	Base Mounting/Bracke mounting/ Embrace hoop mounting/Ground Spike mounting	
Material	Aluminum Alloy	
	PC+PMMA lens	
	Glass	
Finish	Powder Coating	
Fixture Color	Silvery	
EPA	0.35ft ²	1.12ft ²
IK Rating	IK08	
IP Rating	IP66	

LIFESPAN AND WARRANTY

Operating Temperature	-30°C to + 50°C (-22°F to 122°F)
Life Time of LED @Ta=25°C	48000hrs-L80
	77000hrs-L70
	/
Warranty	5 Years

PHOTOMETRY

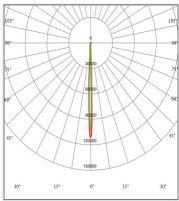

F00110

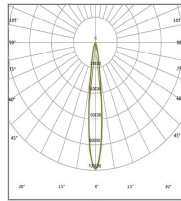

F00111

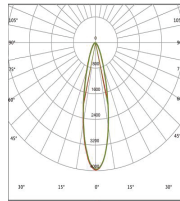

F00113

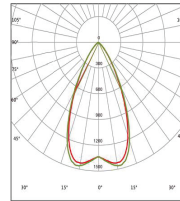

F00114

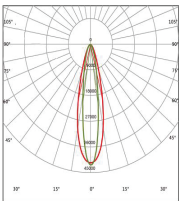

F00115

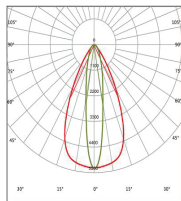

F00116

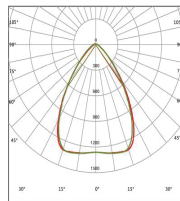

F00117

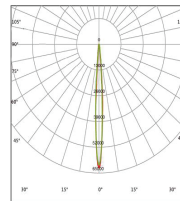

F00118

MOUNTING OPTIONS



BASE
MOUNTING



BRACKET
MOUNTING



EMBRACE
HOOP
MOUNTING



GROUND
SPIKE
MOUNTING

DIMENSIONS

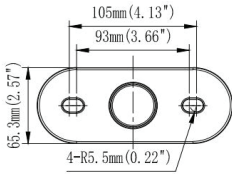
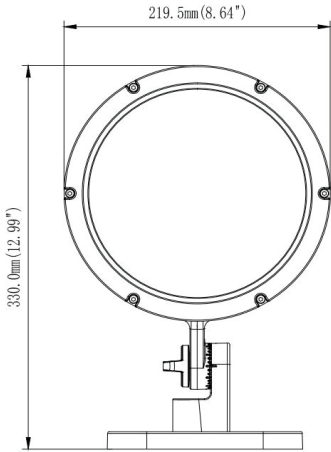

35

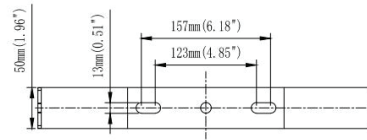
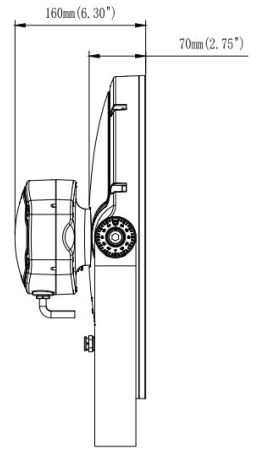
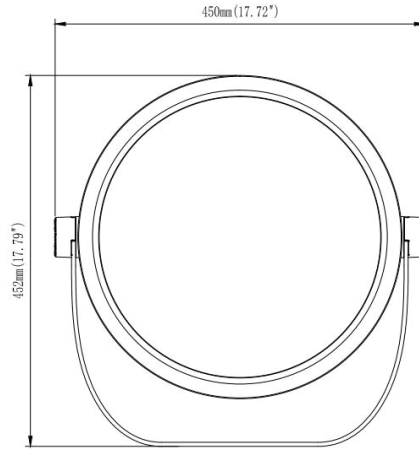
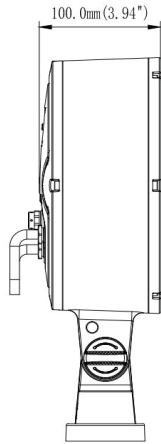

100/150

ACCESSORIES



Safety rope
Stainless steel rope, 1m length.
Code: SL-F33-01 (for 35W-150W)



Visor
Prevention of light pollution.
Code: BC-F39-01 (for 35W)



Visor
Prevention of light pollution.
Code: BC-F39-02 (for 150W)



Ground spike
Code: MT-F39-01



Embrace hoop
Suitable for pipeline installation.
Code: BC-F39-03 (for 35W)